

E N G L I S H

DESIGN
ADJUSTABLE
REVERSIBLE
MULTIFUNCTIONAL
UNIVERSAL

Serie 5

ELECTRIC RIM LOCK



ISEO[®]
iseo.com

Serie 5

- DESIGN
- ADJUSTABLE
- REVERSIBLE
- MULTIFUNCTIONAL
- UNIVERSAL



ADJUSTABLE



REVERSIBLE



MULTIFUNCTIONAL



UNIVERSAL

The contemporary new **DESIGN** is only one of the significant new features of the **SERIE 5**.

ADJUSTABLE BACKSET SIZE: settable to 50, 60, 70 or 80 mm.

REVERSIBLE: the lock can be inverted with a few simple settings.

MULTIFUNCTIONAL: a choice of three internal control configurations is available in a single lock: cylinder only, cylinder and button or button only.

UNIVERSAL: an additional code of the latch only lock (with one product code only) comes complete with special accessories for installation on either steel gates or wooden main entrance doors.

SERIE 5 increases performance while reducing the number of different product codes necessary: **148 conventional lock product codes have been replaced by just 12 codes**, cutting warehousing costs drastically throughout the entire distribution network.



- Less product codes to handle for the wholesaler, improving the quality of the service offered to clients.
- Less shelf space usage for the retailer while still stocking solutions catering for the same number of applications as before.
- Locksmiths and installers no longer need to know the type of lock to be replaced on site.
- Locksmiths can always find the lock that they need when they need it.



52N SERIES

Electric rim locks with
LATCH ONLY



53N SERIES

Electric rim locks
with **LATCH AND
DEADBOLT**



51N SERIES

Electric rim locks with
**LATCH ONLY
FOR OUTWARD
OPENING DOORS**



Attractive, elegant design with ergonomic pull handle grip and premium finish ISEO STYLE polycarbonate cover.

All locks allow for a significant degree of vertical play relative to the respective keep - up to +/-7mm in the case of LATCH ONLY version. **EXTENSIVE GATE DEFORMATION OR DROP TOLERANCE.**

Diam. 26 x 50 mm.

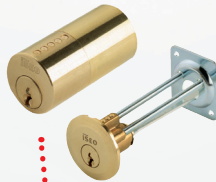

The keep is also adjustable vertically by +/- 1.5 mm. **TO ENSURE CORRECT ALIGNMENT WITH THE LOCK BEFORE DEFINITELY TIGHTENING THE COMPONENTS INSTALLED**



LATCH ONLY locks come as standard with hold-open function (locks set with button/cylinder).

All locks are multifunctional, meaning that the inside opening function may be easily set by the installer, using the key and/or button, if and as necessary. **REDUCED STOCKS, WITH LOCK SET ON SITE.**

Charge piston with lighter spring action. **FOR LIGHTER FRAME STRUCTURES OR FOR USE WITH A DOOR CLOSER.**

Self-locking latch. **TANGIBLE EXTRA SECURITY.**

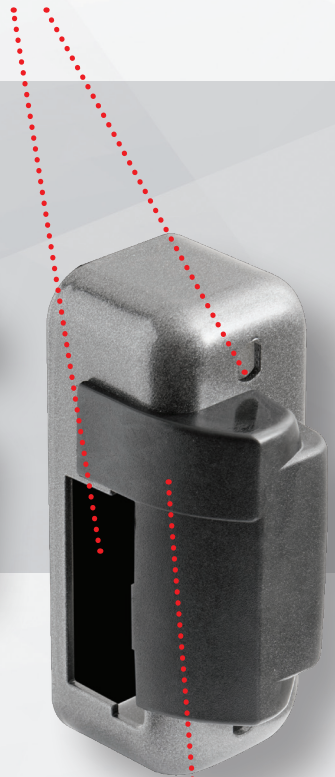

Keep with special anti-friction slide plate instead of roller wheel. **LOWER LATCHING FORCE.**

As a combined result of these features, it has been possible to replace 148 conventional locks product codes with just 12 new product codes.

REDUCED WAREHOUSE SPACE USAGE AND COSTS, INCREASED STOCK AVAILABILITY AND QUICKER DELIVERY TIMES.



All locks have an adjustable backset measurement, settable to 50, 60, 70 or 80 mm. **REDUCED STOCKS, WITH LOCK SET ON SITE.**



All LATCH ONLY locks are reversible (LATCH AND DEADBOLT version is not reversible). **REDUCED STOCKS, WITH LOCK SET ON SITE.**



Version with 2 throw 10+10 mm deadbolt and 23 mm overall protrusion. **EXTRA-SECURE DOOR CLOSURE.**



LATCH ONLY version also available in stainless steel. **FOR USE ON STAINLESS STEEL GATES OR IN HIGHLY CORROSIVE ENVIRONMENTAL CONDITIONS.**

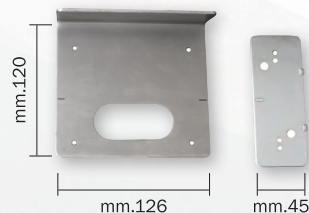

Lock mounting plate and keep backing with alignment markings **TO FACILITATE INSTALLATION.**

- Easily interchangeable with all main products on market today. **EASY REPLACEMENT.**
- Power supply: 12 V AC - 15 W 1.25 A;
- Lock in **ISEO** marbled grey paint finish;
- 3 keys included.
- All settings made directly on lock, even just before definitive fastening. **IT IS NOT NECESSARY TO KNOW DETAILS OF LOCK TYPE NEEDED ON SITE BEFORE INSTALLATION.**



Electric rim locks with
LATCH ONLY
52N SERIES







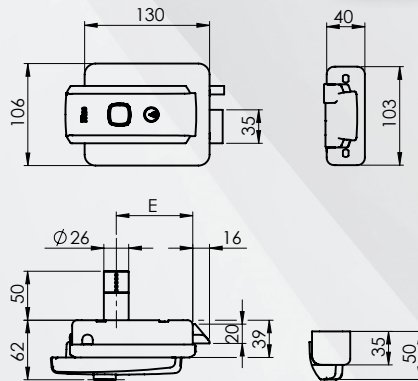

ADJUSTABLE, REVERSIBLE
AND MULTIFUNCTIONAL.

Just 4 new product codes
replacing 76 conventional
locks.

ALL-NEW: The single additional
UNIVERSAL product code
replaces 48 conventional
locks. Comes complete
with special accessories
transforming a fixed cylinder
into a detached cylinder and a
unified keep for both steel and
wood frames.

Manufactured by **ISEO** with
70 mm backset 70 and in
right hand configuration.



CONVENTIONAL LOCKS							Serie 5	UNIVERSAL
TYPE	EXTERNAL CYLINDER	CASE SIZES	RIGHT/LEFT HAND	INTERNAL CONTROL	No.	PRODUCT CODES ELETTRICA 2001	NEW PRODUCT CODES	1 PRODUCT CODE
		50-60-70-80	RH	Cylinder	4	520010**5	52N015	52N005
		50-60-70-80	LH	Cylinder	4	520020**5		
		50-60-70-80	RH	Button only	4	520110**5		
		50-60-70-80	LH	Button only	4	520120**5		
		50-60-70-80	RH	Cyl.+Button	4	520310**5		
		50-60-70-80	LH	Cyl.+Button	4	520320**5		
		50-60-70-80	RH	Cylinder	4	521010**5	52N115	
		50-60-70-80	LH	Cylinder	4	521020**5		
		50-60-70-80	RH	Button only	4	521110**5		
		50-60-70-80	LH	Button only	4	521120**5		
	50-60-70-80	RH	Cyl.+Button	4	521310**5	52N515		
	50-60-70-80	LH	Cyl.+Button	4	521320**5			
	50-60-70-80	RH	Cyl.+Button	4	525010**5			
		50-60-70-80	LH	Cylinder	4	525020**5	52N012	
		50-60-70-80	RH	Cyl.+Button	4	525310**5		
		50-60-70-80	LH	Cyl.+Button	4	525320**5		
		60-70-80	RH	Cylinder	3	520010**2		
		60-70-80	LH	Cylinder	3	520020**2		
		60-70-80	RH	Cyl.+Button	3	520310**2		
		60-70-80	LH	Cyl.+Button	3	520320**2		



Electric rim locks with
LATCH AND DEADBOLT
53N SERIES

ADJUSTABLE AND
MULTIFUNCTIONAL, BUT NOT
REVERSIBLE.

Just 6 new product codes
replacing 48 conventional
locks.

Manufactured by **ISEO** with
60 mm backset and in right
hand configuration

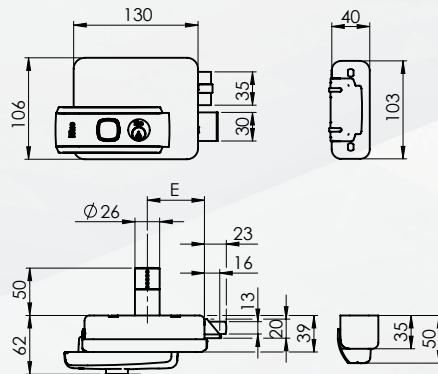

CONVENTIONAL LOCKS							Serie 5
TYPE	EXTERNAL CYLINDER	CASE SIZES	RIGHT/ LEFT HAND	INTERNAL CONTROL	No.	PRODUCT CODES ELETTRICA 2001	NEW PRODUCT CODES
		50-60-70-80	RH	Cylinder	4	530010**5	53N0151
		50-60-70-80		Cyl.+Button	4	530210**5	
		50-60-70-80	LH	Cylinder	4	530020**5	53N0152
		50-60-70-80		Cyl.+Button	4	530220**5	
		50-60-70-80	RH	Cylinder	4	535010**5	53N5151
		50-60-70-80		Cyl.+Button	4	535210**5	
		50-60-70-80	LH	Cylinder	4	535020**5	53N5152
		50-60-70-80		Cyl.+Button	4	535220**5	
		50-60-70-80	RH	Cylinder	4	531010**5	53N1151
		50-60-70-80		Cyl.+Button	4	531210**5	
		50-60-70-80	LH	Cylinder	4	531020**5	53N1152
		50-60-70-80		Cyl.+Button	4	531220**5	



Electric rim locks with
LATCH ONLY FOR OUTWARD OPENING DOORS
51N SERIES

ADJUSTABLE, REVERSIBLE, AND MULTIFUNCTIONAL.

Just 2 new product codes replacing 24 conventional locks.

Manufactured by **ISEO**. with 70 mm backset and in right hand configuration.

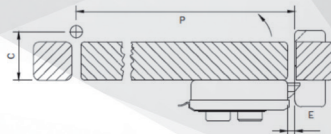

CONDITIONS FOR INSTALLATION ON OUTWARD OPENING DOORS

- DIMENSION C: max. centre distance between hinge and inner door edge 80 mm
- DIMENSION P: min. door width 900 mm
- DIMENSION E: max. distance between lock and keep 9 mm

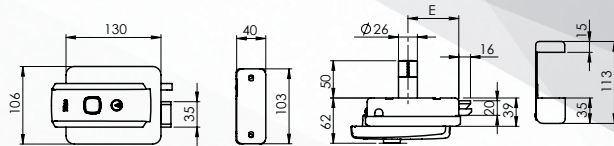

CONVENTIONAL LOCKS							Serie 5
TYPE	EXTERNAL CYLINDER	CASE SIZES	RIGHT/LEFT HAND	INTERNAL CONTROL	No.	PRODUCT CODES ELETTRICA 2001	NEW PRODUCT CODES
		50-60-70-80	RH	Cylinder	4	510010**5	51N015
		50-60-70-80	LH	Cylinder	4	510020**5	
		50-60-70-80	RH	Cyl.+Button	4	510310**5	
		50-60-70-80	LH	Cyl.+Button	4	510320**5	
		50-60-70-80	RH	Cyl.+Button	4	511310**5	51N115
		50-60-70-80	LH	Cyl.+Button	4	511320**5	

Serie 5 CODES:



- 5** - Electric rim lock
- 2** - Latch, Outward opening
- N** - New
- 0** - Fixed cylinder
- 1** - Detached cylinder
- 5** - Fixed cylinder and plated
- 0** - Universal
- 1** - Multifunctional
- 2** - Stainless Steel
- 5** - Marbled Grey Paint Finish
- 1** - Right
- 2** - Left
- For locks with deadbolt



ISEO®



THE ISEO GROUP

ISEO IS A GROUP WITH SIGNIFICANT INTERNATIONAL PRESENCE. IT IS AN ALTERNATIVE TO BRANDS OWNED BY LARGE FINANCIAL HOLDINGS.

A TEAM OF COMPANIES, EACH WITH THEIR OWN MANAGEMENT, AREA OF SPECIALISATION, ENTREPRENEURIAL SKILLS AND PRODUCTION PLANTS, WHICH WORK TOGETHER IN SYNERGY TO OFFER THE CLIENT THE BEST POSSIBLE PRODUCTS AND SERVICE QUALITY.



Iseo Serrature s.p.a.
Via San Girolamo 13
25055 Pisogne (BS)
Italy
Tel. + 39 0364 8821
iseo@iseo.com